



FOUNTEN

# Installation Guide

## FS-STAT-32ACH

### Thermostat with Humidity Control

## Caution

Failure to follow these instructions can damage the product or cause a hazardous condition. Disconnect power during the installation of this product. All wiring must conform to local codes and ordinances. This thermostat is designed for use with 24 VAC systems.

For additional assistance visit [www.Founten.com](http://www.Founten.com) to request support.

## Before Removing Old Thermostat

Note the colors and letter designations of the terminal connections on the existing thermostat to assist in identifying the correct wiring connections.

## Wall Mounting

The rear cover of the thermostat is mounted to the wall. To separate the front cover from the rear cover, simply grasp the front and back of the thermostat firmly and pull apart.

Attach the rear of the thermostat to the wall using the included Plastic Anchors. Position the rear cover so that the wires can be fed through the rectangular opening in the back of the thermostat. Then mark the locations of the mounting points on the wall. Drill a 3/16" hole for each anchor. Insert the anchors into the wall and attach the rear cover using the included screws. The thermostat can also be mounted to an electrical box using the included machine screws.

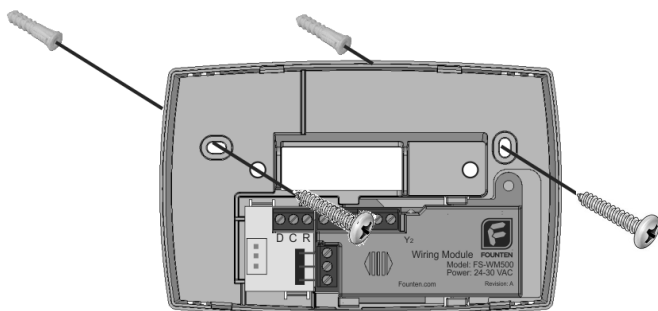

# Terminal Designations

## Conventional

R	24 VAC Power for Heat
Rc	24 VAC Power for Cool
C	Common 24 VAC
Y	Cool Control – stage 1
W	Heat Control – stage 1
G	Fan Control
W2	Heat Control – stage 2
Y2	Cool Control – stage 2
Hu	Humidify
Dh	Dehumidify
D	Data (Not Used)

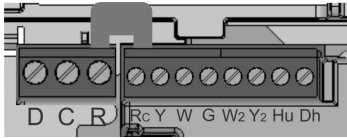

## Heat Pump

R	24 VAC Power for Heat
Rc	Jumper to Terminal “R”
C	Common 24 VAC
Y	Compressor – stage 1
O/B (W)	Reversing Valve
G	Fan Control
Aux (W2)	Auxiliary/Emergency Heat
Y2	Compressor – stage 2
Hu	Humidify
Dh	Dehumidify
D	Data (Not Used)

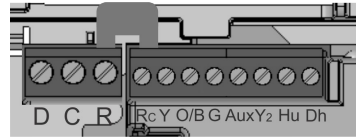

**Note:** Remove jumper between R & Rc for two Transformer systems.

## Standard Wire Colors

Most thermostat installations follow standard wire color designations. This should be verified for your installation. These standard colors are:

Terminal	Color	Description
R, Rc	Red	24 VAC Power
W	White	Heat Control
G	Green	Fan Control
Y	Yellow	Cool Control
C	Black	24 VAC Common
Y2	Blue or Orange	Cool Control - Stage 2
W2	Varies	Heat Control – Stage 2
Aux	Varies, blue, pink, gray, tan	Auxiliary or Emergency Heat
O/B	Varies, Orange	Reversing Valve
Hu	Varies	Humidify Control
Dh	Varies	Dehumidify Control

# Wiring Guide

The follow wire connection guide should be used for your installation. This guide shows the most common configurations. Contact Fouten for assistance with configurations not shown on this guide.

## Conventional Systems

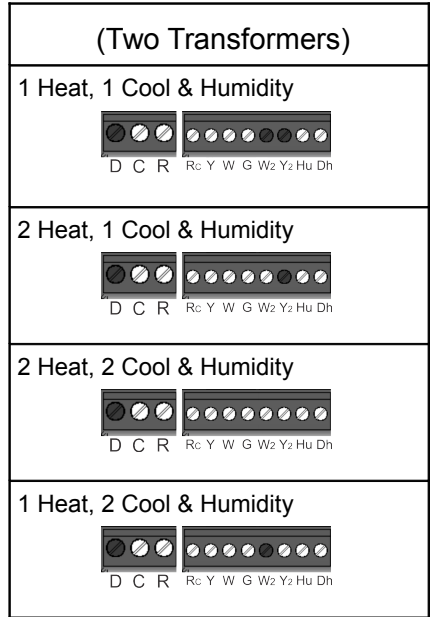
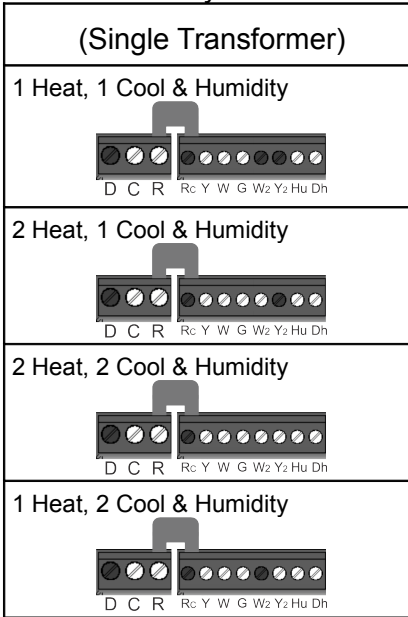

## Heat Pump Systems

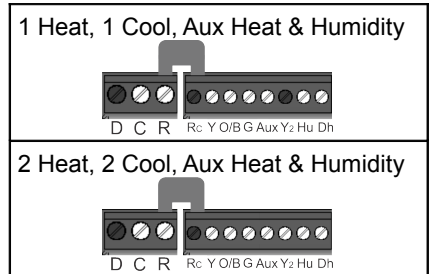
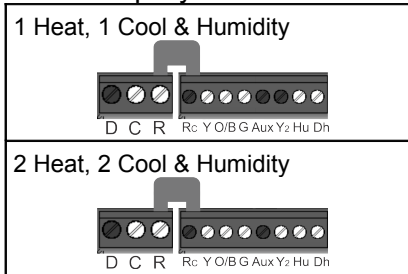

## Humidity Control

The humidity control terminals provide 24VAC 1Amp outputs. Systems which are controlled by dry contact inputs will require an additional 24VAC relay which is powered using the humidity control output and Common.

## Configuration

All of the thermostat configuration settings can be made through the Fouten Site Manager Web Application. These can be found under the *Admin* section. Each

thermostat will be listed with its serial number and the label *Thermostat Setup*. Most configuration items can be left at their default setting. For proper operation it is necessary to set the correct System Type (Conventional or Heat Pump). If the Web Application is not yet available, the System Type can be set directly using the thermostat front keypad.

## Setting System Type Using the Keypad

The thermostat can only be placed in configuration mode during the first minute after the unit has been powered on. If the unit has already been running for longer than 1 minute, remove the front of the thermostat from its base and then re-attach it. This will cause it to recycle the power.

With the thermostat powered on, verify that the System Mode is “Off”, then press and hold the up and down arrow keys simultaneously for 5 seconds. This will place the thermostat in configuration mode and the display will change to show one of the 3 possible system type settings:

Conventional System (Default)	
Heat Pump “W” Terminal Controls Reversing Valve. Energized for Cool.	
Heat Pump “W” Terminal Controls Reversing Valve. Energized for Heat.	

The system type can now be selected by pressing the up arrow key on the thermostat. Once the correct setting has been selected, press any other button and the thermostat will return to normal operation.

## Alternate Limited Wiring Installation

Some installations may have limited in-wall wiring. In these cases the thermostat can be specially configured to use only 3 wires. This configuration is accomplished by removing the internal WM500 Wiring Module which is included in every thermostat and installing it at the furnace location. This configuration can be used when a Common wire is not available to power the thermostat or when a site is upgrading a single stage system to a multi-stage system.

To remove the Wiring Module, start by loosening the R and Rc terminal screws and removing the jumper between R and Rc. Loosen the three terminals on the Wiring Module labeled R, C, and D. Slide the module to the right and remove from the rear of the thermostat.

Install the Wiring Module inside the furnace using the standard terminal designations shown above. In single transformer systems connect a jumper wire between R and Rc on the Wiring Module.

Now connect the R, C, and D wires from the Wiring Module to the matching terminals on the Thermostat using the existing in-wall wiring.